



SIAT

M. J. MAILLIS GROUP

HM11-T/TB

HM145

HM146

Hot Melt Case Sealers



CE

for more details:



HM11



HM145



HM146

HM11-T/TB

HM11-T automatic hot melt carton sealer.

HM11-T is an automatic case sealer with side drive belts and manual adjustment. It is designed to seal with Hot Melt glue the top of boxes of the same size.

The box, coming from a filling station with the bottom flaps sealed, is taken away by drive belts toward the machine where injectors dispense 4 strips of Hot Melt glue. A system of flap compression rollers provides the proper pressure on top flaps of boxes.

The Hot Melt case sealer doesn't require the presence of an operator except for the glue adjustments and feeding. It is equipped with safety panels to prevent an operator from coming in contact with moving or hot parts.

HM11-TB automatic hot melt carton sealer.

HM11-TB is an automatic case sealer with side drive belts and manual adjustment. It is designed to seal with Hot Melt glue the top and bottom of boxes of the same size.

The box, coming from a filling station with the bottom flaps sealed, is taken away by drive belts toward the machine where injectors dispense 4 strips of Hot Melt glue. A system of flap compression rollers provides the proper pressure on top and bottom flaps of boxes.

The Hot Melt case sealer doesn't require the presence of an operator except for the glue adjustments and feeding. It is equipped with safety panels to prevent an operator from coming in contact with moving or hot parts.

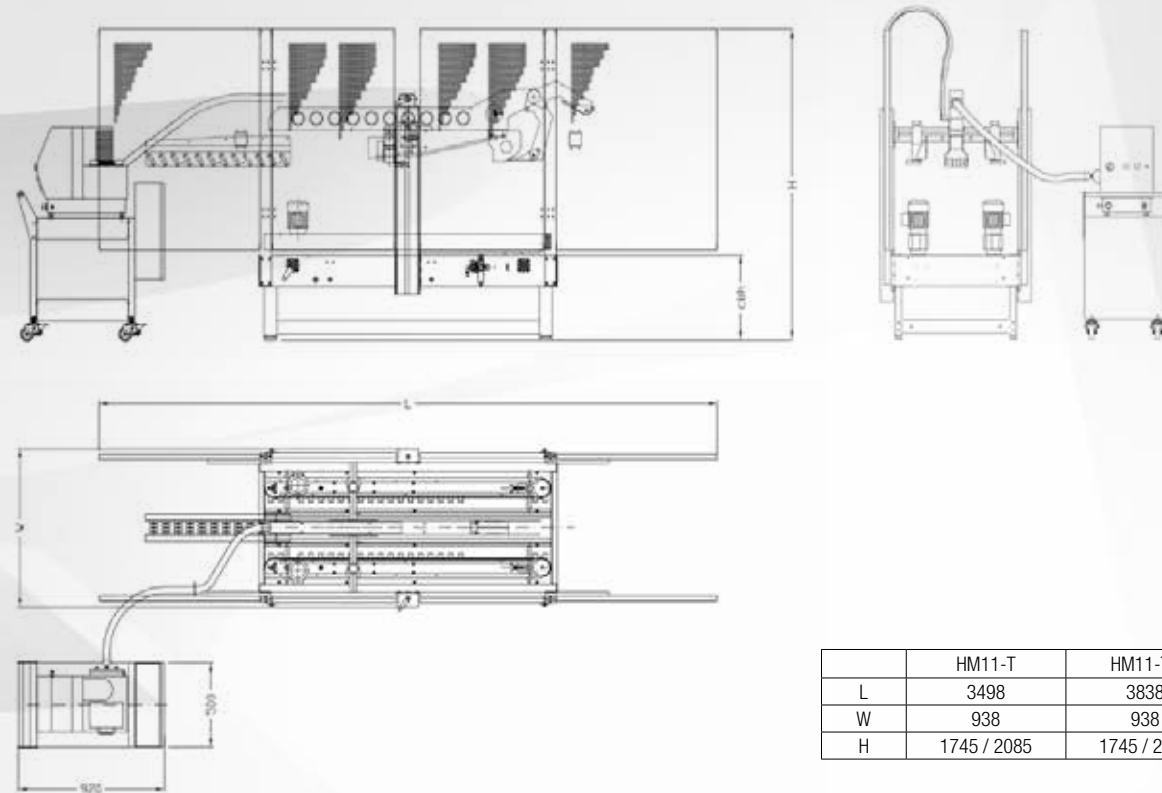

Key Features

- Manual adjustment on the different box sizes (width,height,length) by handles
- Side drive belts (2 x 75 mm width each)
- 2 x Motors kW 0,18 each

HM11-T:

- The top glue dispensing applicator dispenses the glue on the top flaps while boxes pass through the machine before the top flaps folding

HM11-TB:

- The top & bottom glue dispensing applicator dispenses the glue on the top and bottom flaps while boxes pass through the machine before the top flaps folding
- ROBATECH® Hot Melt glue dispenser on an external carriage with casters equipped with 5 Kg tank, tube and glue applicator included (other brands on request)
- The glue dispenser adjusts glue temperature & volume
- Storing of sealing programs
- Timer setting to allow pre-heating adjustment
- Box dimensions adjustment
- Side safety protections with stop emergency button and switches to disconnect electric & pneumatic circuits
- Control panel equipped with: main switch start, stop button, stop emergency button and photocells to control glued boxes passing
- Machine controlled by PLC

HM11-T/TB

HM11-T and HM11-TB are automatic case sealers with side drive belts and manual adjustment. They are designed to seal with Hot Melt glue the top and bottom of boxes of the same size.

The box, coming from a filling station with the bottom flaps sealed, is taken away by drive belts toward the machine where injectors dispense 4 strips of Hot Melt glue. A system of flap compression rollers provides the proper pressure on top and bottom flaps of boxes.

The Hot Melt case sealers don't require the presence of an operator except for the glue adjustments and feeding. They are equipped with safety panels to prevent an operator from coming in contact with moving or hot parts.



Folding system of bottom flaps (only HM11-TB)



HM11-TB
Optional polycarbonate safety panels

Optional touchscreen panel



Upper Hot Melt glue dispensing applicator

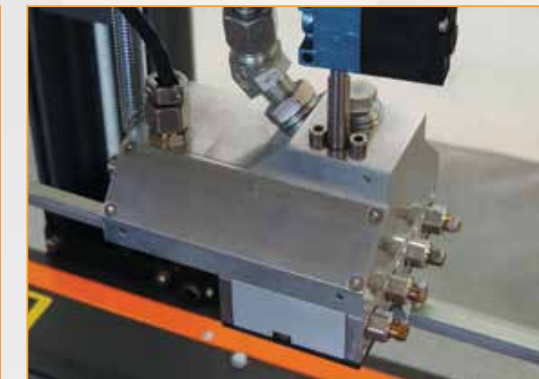

for more details:



HM145/146

HM145 and HM146 are automatic case erectors with side drive belts and manual adjustment. They are designed to seal with Hot Melt glue the bottom of boxes. The operator, after having filled the box storage with boxes and adjusted the machine, turns "On" switch. The machine automatically takes a box from the boxes storage. A carriage drags the box which is automatically opened by a box-opener lever. Then the box is taken away by a second carriage through side drive belts to start the folding operations.



Control panel



HM145/146 front view of DX model



HM145/146 boxes storage view DX model

Detail of folding system of the bottom flaps



Key features of HM145:

- Box storage for 150 boxes
- Box storage available on left side (SX) or right side (DX)
- 2 carriages activated by a pneumatic system with suction cups to take cartons from the boxes storage, to fold and to take them away by drive belts (2 x Motors kW 0,55 each) for the bottom flaps folding & sealing with Hot Melt glue
- ROBATECH® Hot Melt glue dispenser positioned on an external carriage with casters (other brands on request)
- VENTURI® vacuum system
- Control panel equipped with: box counter - box timer, low box storage alarm, glue end alarm, full line alarm after the machine
- Safety protections with switches to disconnect electric and pneumatic circuits if opened
- Machine controlled by PLC

Key features of HM146:

- Box storage for 150 boxes
- Box storage available on left side (SX) or right side (DX)
- 2 carriages activated by a pneumatic system with suction cups to take cartons from the boxes storage, to fold and to take them away by drive belts (2 x Motors kW 0,55 each) for the bottom flaps folding & sealing with Hot Melt glue
- ROBATECH® Hot Melt glue dispenser positioned on an external carriage with casters (other brands on request)
- VENTURI® vacuum system
- Control panel equipped with: box counter - box timer, low box storage alarm, glue end alarm, full line alarm after the machine
- Safety protections with switches to disconnect electric & pneumatic circuits if opened
- Machine controlled by PLC

How to choose between a right hand and a left hand machine when using printed boxes

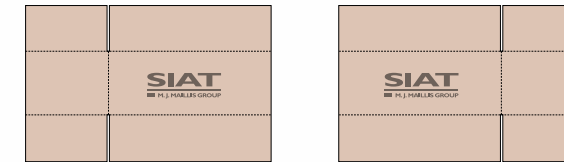

Modifications to be done on the squared boxes

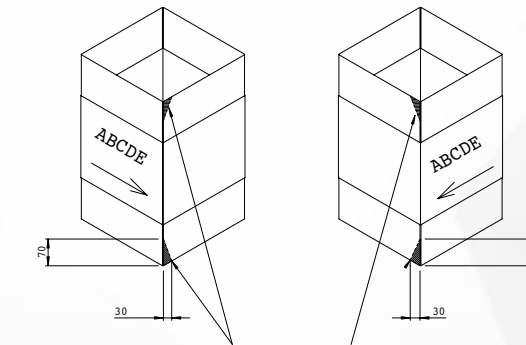

Overall machine dimensions with standard or optional extended box storage

	HM145	HM146
A	3110	3280
B1	2290	2290
B2	3290	3290
C	1002	1020
D	1317	1320
H	1790 / 1890	1790 / 1890

Standard box storage capacity: 80 ÷ 150 boxes according to thickness.

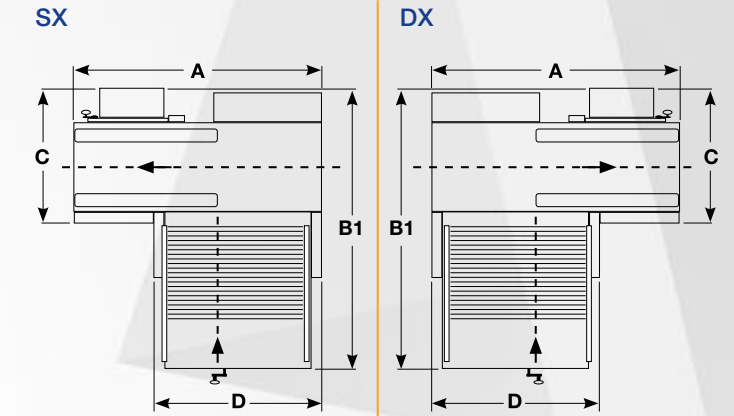

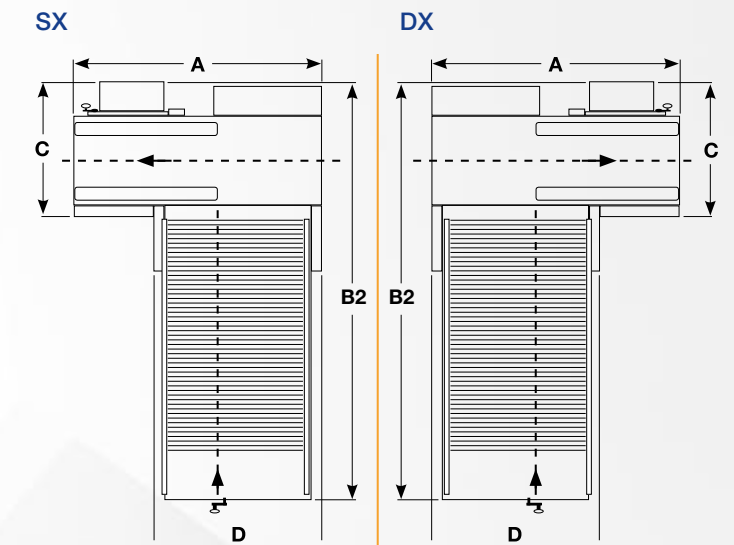

Extended box storage capacity: 160 ÷ 300 boxes according to thickness.



> **Machine dimensions**
Dimensioni macchina
Machinemessungen
Dimensions machine
Dimensiones de máquina

> **HM11-T/TB**> **HM145**> **HM146**

Size / Weight packaging			LxWxH 
> HM11-T	255	350	270x120x213
> HM11-TB	420	550	305x120x213
> HM145	780	1000	310x235x265
> HM146	830	1050	330x235x265

	Min.	Max
H	1745	2085
cbh	485	825
AS 77	585	925
AS 80	685	1025

	Min.	Max
H	1790	1890
cbh	545	645
AS 109	665	765
AS 80	n.a.	n.a.

	Min.	Max
H	1790	1890
cbh	545	645
AS 109	665	765
AS 80	n.a.	n.a.

> **Box dimensions**
Dimensioni delle scatole
Kartonabmessungen
Dimensions des boîtes
Dimensiones de cajas

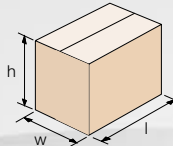
> **HM11-T**> **HM11-TB**> **HM145**> **HM146**

	Min.	Max
l	200	600
w	150	500
h	150	500

	Min.	Max
l	200	500
w	150	500
h	150	500

	Min.	Max
l	200	560
w	150	350
h	200	450

	Min.	Max
l	300	600
w	200	400
h	200	450

> **Production capacity**
Capacità di produzione
Produktionskapazität
Capacité de production
Capacidad de producción

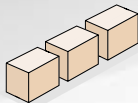
> **HM11-T**

Bph

Max pcs.* 1200

> **HM11-TB**

Bph

Max pcs.* 1000

> **HM145**

Bph

Max pcs.* 500

> **HM146**

Bph

Max pcs.* 400

* Always based on shorter manageable box

> **Air consumption**
Consumo aria
Luftverbrauch
Consommation d'air
Consumo de aire

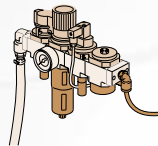
> **HM11-T**

NL.

Cycle 2,1

> **HM11-TB**

NL.

Cycle 2,2

> **HM145**

NL.

Cycle 12

> **HM146**

NL.

Cycle 12

from 5,5 bar to 7 bar

> **Standard voltage**
Votaggio standard
Standardspannung
Tension standard
Voltaje estándar

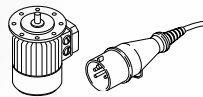
> **HM11-T**

380/400V - 50Hz - 3F	
440V - 60Hz - 3F	
Amps	1,33
Power kW	0,36
Phase	3Ph+PE

> **HM11-TB**

380/400V - 50Hz - 3F	
440V - 60Hz - 3F	
Amps	1,33
Power kW	0,36
Phase	3Ph+PE

> **HM145**

380/400V - 50Hz - 3F	
440V - 60Hz - 3F	
Amps	3,93
Power kW	1,11
Phase	3Ph+PE

> **HM146**

380/400V - 50Hz - 3F	
440V - 60Hz - 3F	
Amps	3,93
Power kW	1,11
Phase	3Ph+PE

> **Robatech® Hot-Melt applicator (other brands on request)**

380/400V - 50Hz - 3F	
440V - 60Hz - 3F	
Amps	5,2
Power kW	2,37
Phase	3Ph+N+PE

380/400V - 50Hz - 3F	
440V - 60Hz - 3F	
Amps	6
Power kW	2,56
Phase	3Ph+N+PE

380/400V - 50Hz - 3F	
440V - 60Hz - 3F	
Amps	4,5
Power kW	2,24
Phase	3Ph+N+PE

380/400V - 50Hz - 3F	
440V - 60Hz - 3F	
Amps	4,5
Power kW	2,24
Phase	3Ph+N+PE

> **Optionals**
Accessori
Zubehör
Accessories
Accesorios

> **AS80 (only for HM11)**

Higher legs
Set gambe più alte
Höhere Stützen
Pieds plus hauts
Patas más altas



h 600mm

> **AS77 (only for HM11)**

Casters
Set ruote
Rädchen
Roulettes
Ruedas

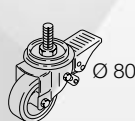

Ø 80

> **AS109**

Casters
Set ruote
Rädchen
Roulettes
Ruedas

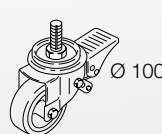

Ø 100

> **RG**

Roller conveyor
Piani a rulli
Rollenbahnen
Plans à rouleaux
Rodillos libres

> **GTL - GTR**

Extendable conveyor
Rulliera estensibile
Ausziehbare rollenbahnen
Convoyeur extensible
Rodillos extensibles

