

# SIAT

MAILLIS

## SK20 Semi-Automatic Carton Sealers



**RELIABLE MACHINE**  
Strong frame with  
dual masts structure



**TIME SAVING SOLUTION**  
Fast removable  
top taping head

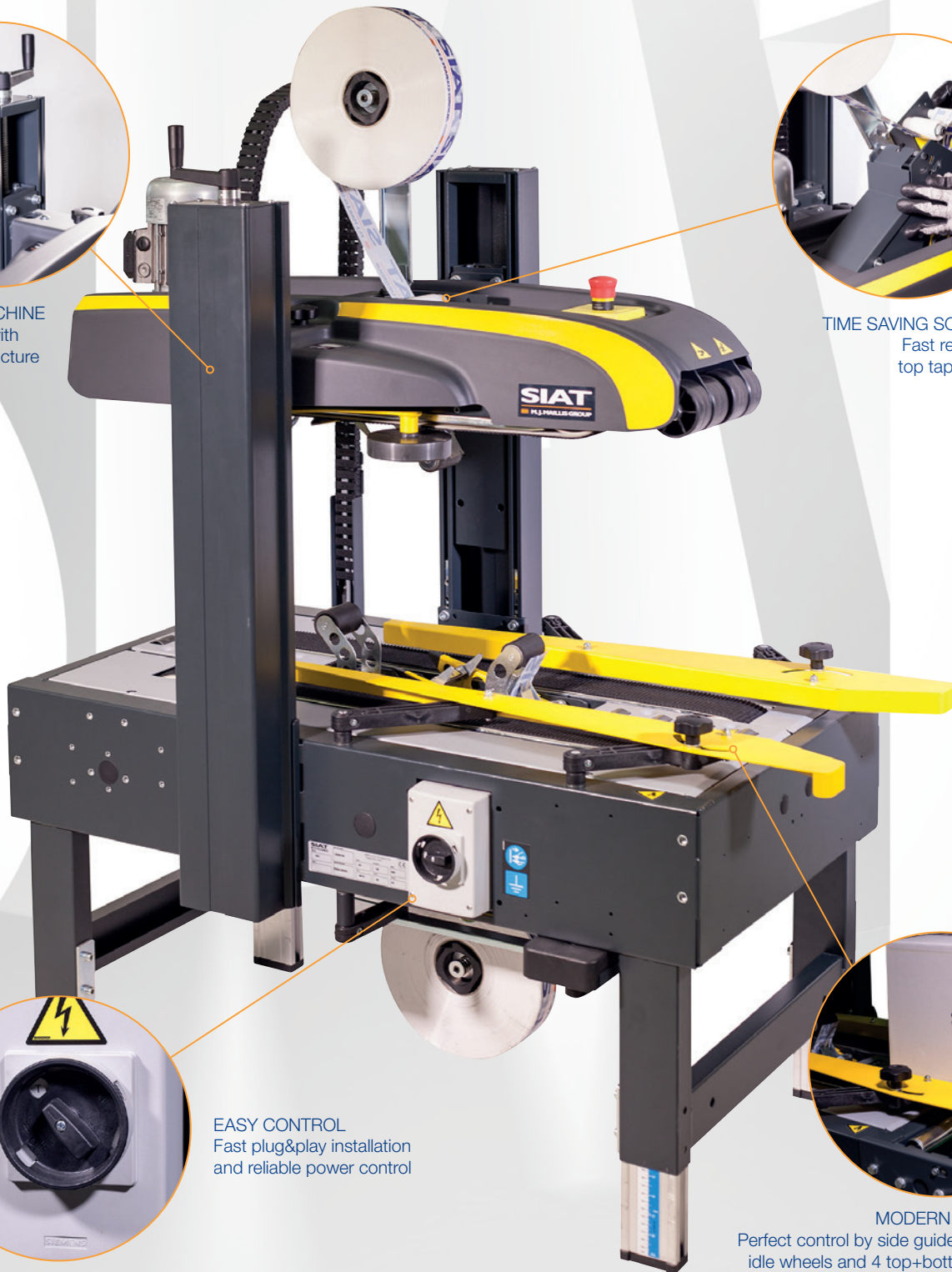

**EASY CONTROL**  
Fast plug&play installation  
and reliable power control



**MODERN DESIGN**  
Perfect control by side guides, upper  
idle wheels and 4 top+bottom belts

CE

for more details:



SK20

The new case sealer SK20 represents the perfect solution for your semi-automatic packaging line.

The concept, with the double top and bottom drive belts, allows the control of the carton box also during the incoming process before sealing.

Thanks to the robust dual masts frame and to the primary level of the machine components, the historical reliability of SIAT machines is fully guaranteed.

The easy plug&play mode and the fast-removable taping head help the customer to save time efficiently during set-up and maintenance operations.

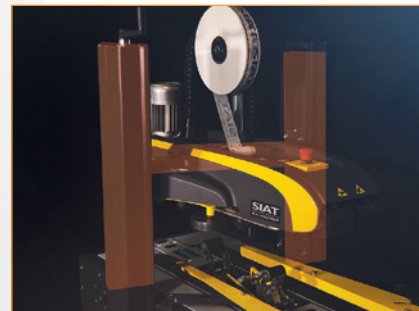

other languages: [www.siat.com](http://www.siat.com)



> **Machine dimensions**  
Dimensioni macchina  
Machinemessungen  
Dimensions de la machine  
Dimensiones de máquina

Packaging size / weight			LxWxH 
> SK20	150	170	114x78x115

> SK20

	Min.	Max
L	1080	-
W	740	-
H	1290	1630
cbh	485	825
AS 77	cbh +110	cbh +110
AS 80	cbh +160	cbh +160

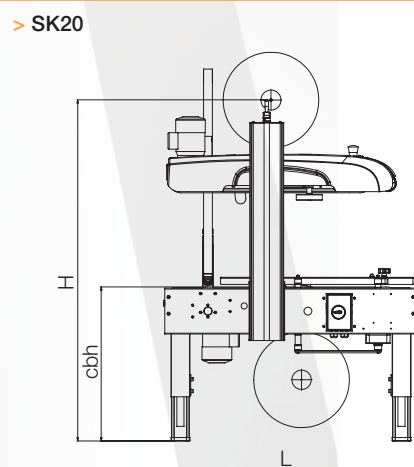

> **Box dimensions**  
Dimensioni delle scatole  
Kartonabmessungen  
Dimensions des boîtes  
Dimensiones de cajas

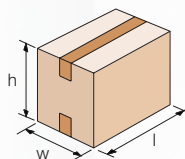

> SK20

	K11R std. / K12R on demand	
	Min.	Max
l	150	∞
w*	140 / 170	500
h	100	500

\* With top side pressure rollers (minimum width manageable 205 mm).  
Upper guides required in case of box width less than 205 mm (optional).

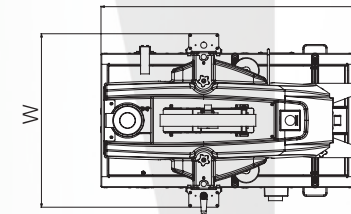

> **Production capacity**  
Capacità di produzione  
Produktionskapazität  
Capacité de production  
Capacidad de producción

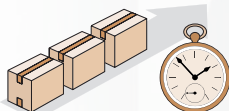

> SK20

Max pcs.*	Bph
	1200

\* Always based on shorter manageable box

> **Standard voltage**  
Voltaggio standard  
Standardspannung  
Tension standard  
Voltaje estándar

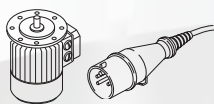

> SK20

<b>380/415V - 50Hz - 3P</b>	
Amps	1,08
Power kW	0,26
Phase	3Ph + N + PE

> **Taping units**  
Unità nastranti  
Verschliesseinheiten  
Unités enrubanneuses  
Unidades de precinto

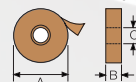

	K11R/ K12R	
	mm	
A	410 Max	
B	50 / 75	
C	76	

> **Optionals**  
Accessori  
Zubehör  
Accessories  
Accesorios

> **AS80**  
Higher legs  
Set gambe più alte  
Höhere Stützen  
Pieds plus hauts  
Patas más altas

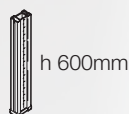

> **AS77**  
Casters  
Set ruote  
Rädchen  
Roulettes  
Ruedas

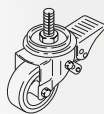

> **RG**  
Roller conveyor  
Piani a rulli  
Rollenbahnen  
Plans à rouleaux  
Rodillos libres



> **GTL - GTR**  
Extendable conveyor  
Rulliera estensibile  
Ausziehbare rollenbahnen  
Conveyeur extensible  
Rodillos extensibles

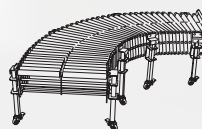

> **K-125 / K-250**  
Inkjet printer  
Stampante ad inchiostro  
Tintenstrahldrucker  
Marqueur à jet d'encre  
Impresora de inyección de tinta

