

**NEW**



# NASTRO-SB™ X-Series

Automation Grade	<i>SEMI</i>	<i>Fully</i>	Use Intensity	<i>LOW</i>	<i>Medium</i>	<i>High</i>
Format Setting	<i>MANUAL</i>	<i>Automatic</i>	Box Dimension	<i>SMALL</i>	<i>MEDIUM</i>	<i>Large</i>

## DATASHEET

SAFE • SUSTAINABLE • SIMPLE

### Semi-Automatic Case Sealer

Nastro-SB™ X-Series is a range of semi-automatic case sealing machines designed and engineered by SIAT specifically for small - medium fixed boxes. Nastro-SB™ X-Series is the ideal case sealing machine for a variety of industries like food & beverage, chemical, clothes and wine.

#### KEY FEATURES

- ✓ **Practical** - Seals upper & lower flaps of cardboard cases or cartons
- ✓ **Added Protection** - Lockable electric isolation switch
- ✓ **Safety First** - Central emergency stop to work safety on both sides of the machine
- ✓ **Taping Heads** - Available with K11 or K12 taping heads
- ✓ **Simple Operation** - Intuitive and quick machine set-up
- ✓ **Quality Build** - Best-In-Class components with SIEMENS electrics
- ✓ **New feature** - Top taping head removable
- ✓ **Improved Design** - Quick release Taping Heads (Top & Bottom – No tools required)
- ✓ **CE compliant** - Engineered and produced in Italy according to EU safety standards

#### MACHINE DIMENSIONS

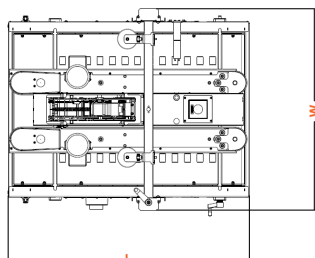
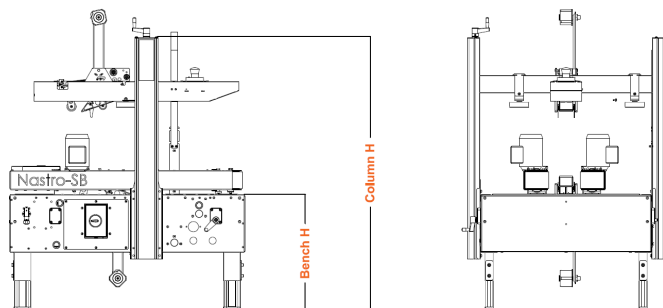

Machine Dimensions		
	Min (mm)	Max (mm)
H Column	1.275	1.535
H Bench	540	800
W	920	
W Bench	800	
L	1.100	

Standard Power Supply	
380/415V - 50Hz - 3ph	
440V - 60Hz - 3ph	
Amps	1,08
Power kW	0,18
Phase	3Ph + PE



#### Also available:

- **L-Version**  
for narrow and very flat boxes
- **OB-Version**  
for taping only on bottom side (w/o columns and top structure)



# NASTRO- SB™ X-Series

## DATASHEET

### Technical Data

Belt position	Lateral (Left & Right)
Box Size	Medium (std.) + Small (L-Version)
Min / Max box weight	0,5 - 32 kg
Default Taping Head	K11 for 2" = 50 mm
Alternative Taping Heads	K12 for 3" = 75 mm
Power Consumption (std.)	0,18 kw
Air Consumption (NL/Cycle)	-
Operator Side	Left (std.) / Right
Tape width (mm)	50 (std.) / 75
Tape Leg (mm)	70 (std.) / 50 / 30
Ingress Protection Code	IP54
Ambient Operating Temperature	5 – 40 °C
Maximum level of noise	Depending on tape quality

### Features

Removable Top Taping-Head	• (std. w/o tools)
Removable Bottom Taping-Head	• (std. w/o tools)
Adjustable Tape Leg	•
Pre-Installed & Easy-To-Mount	•
Adjustable Tape Contact Pressure	•
Autom. Box Format Setting	-
Flap Folding Function	• (opt. 3-flap-folder)
Belt Speed Selection	-
Fully Automatic Operation	-
SIAT Taping-Logic on board	-

### WORKBENCH HEIGHT

#### Dimensions (mm)

Workbench Height Z	540 – 825
Optional wheels*	+ 110
Optional elongated legs*	+ 220
Optional shorter legs*	- 100

\* Indicated dimensions for optional wheels and legs must be added or subtracted from the basic dimensions.

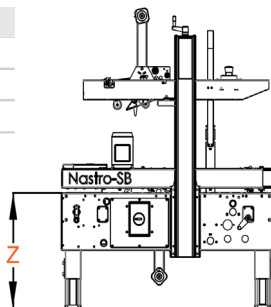

### BOX DIMENSIONS & PRODUCTIVITY

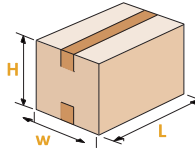

<sup>1</sup> W = 105 mm as L-Version  
H = 50 mm as L-Version & tape-leg 30 mm

<sup>2</sup> 90 mm with 30 mm tape leg  
100 mm with 50 mm tape leg  
120 mm with 70 mm tape leg

Box Dimensions	L (mm)	W (mm)	H (mm)
Min.	150	150 <sup>1</sup>	120 <sup>2</sup>
Max.	∞	500	500

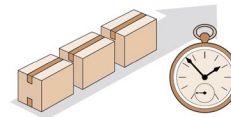

Max. production capacity:  
**Up to 1.200\* BPH**

\*Based on the shortest processable box length and provided an optimum continuous box infeed by the operator.

### PROCESSABLE TAPES

Base Material	PVC / OPP / PET / Paper*
Adhesive Type	Solvent / Hot Melt / Acrylic
Special Tape	Filament-Tape** / Safety-Seal-Tape***

\*with limitations \*\*special tape cutting blade required \*\*\*need of a test might be necessary

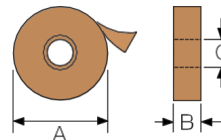

K11R / K12R	
A	Max. 410 mm
B	50 / 75 mm
C	76 mm

### BOX REQUIREMENTS

Quality result of the taped box depends on the general box quality and dimensional accuracy, as well as the quality of tape used.

Box Types: FEFCO 0201 / 0200\* – RSC / HSC\*

[other types may be possible as well]

\* FEFCO 0200 / HSC with OB-Version (only bottom taping) or on request

Adverse Impact Factors	Underfilling	Overfilling	Weak Boxes

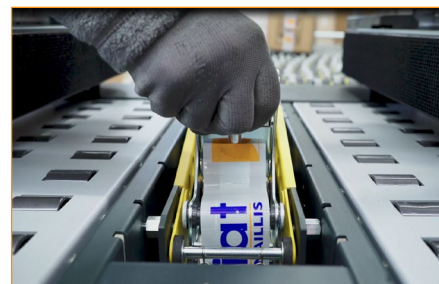
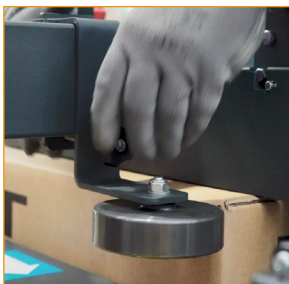

### OPTIONS & ACCESSORIES

- Operation side "Right" (std. "Left")
- Special cutting blades filament-tape
- Taping Head for 25/30 or 38mm width
- Power Supply 220/230V – 50hz – 1ph
- Higher Legs
- Casters / Wheels
- Fix & Extendable Roller Conveyors
- 3-Flap-Folder
- Box Holder
- Energy Saving Kit
- End/Break Tape Device

### MORE DETAILS

Videos and further information can be found on our website or SIAT Youtube channel.

